



ISSN: 0851-0881

<https://revues.imist.ma/index.php/langues-litteratures>

Allomorphy of the anticausative marker and the verbal left-edge in Taqbaylit

Amazigh Bedar

How to cite this article: Bedar, Amazigh. (2023). Allomorphy of the anticausative marker and the verbal left-edge in Taqbaylit. *Langues et Littératures*, 28, 27-51.

Allomorphy of the anticausative marker and the verbal left-edge in Taqbaylit*

Amazigh Bedar

Laboratoire de linguistique de Nantes

UMR 6310, CNRS/Nantes Université

Abstract

This paper addresses the issue of allomorphy of the anticausative prefix /n-/ in light of the verbal left-edge in Taqbaylit. This prefix is in fact an independent morpheme in Taqbaylit although it has been considered in the Berber literature to be an allomorph of /m-/ when combined with a stem containing a labial consonant (Bensoukas, 2014; Boukous, 2009; Chaker, 1995; Elmedlaoui, 2012; Idrissi, 2001; Kossmann, 2007; a.o.). The aim is to study the underlying representation and the surface allomorphy of this prefix, which has two phonetic realizations: a simplex [n] and a geminate [nn]. Indeed, it is realized as a geminate in CC contexts and as a simplex in CV contexts. However, when it is combined with the causative prefix /s-/, it surfaces only as a simplex regardless of its right-context. I will analyze the status of this prefix within Strict CV phonology (Lowenstamm, 1996, 1999; Scheer, 2004) and show that (i) /n-/ is a simplex floating morpheme and (ii) its surface form depends on both Licensing and a templatic property of the left-edge of the verb. This implies, as it will be shown, that the verbal left-edge in Taqbaylit is composed of two CV units, each hosting its own morphemes.

Received: Jan.13, 2023

Revised: March 6, 2023

Accepted: March 14, 2023

Keywords

Taqbaylit; anticausative;
n-verbs; allomorphy;
left-edge; strict CV

* I would like to thank Sabrina Bendjaballah, Oana Lungu, and two anonymous reviewers for valuable comments. All possible mistakes are my own.



amazigh.bedar@univ-nantes.fr



<http://orcid.org/0000-0003-4913-3165>

1. Introduction

The literature dealing with Berber languages in general and Taqbaylit (Kabyle) in particular, traditionally distinguishes three derivational prefixes in verbs: the causative /s-/, the reciprocal /m-/ and the passive /t^swa-/. Bedar (2022) has recently argued for the existence of a fourth morpheme, the prefix /n-/, which marks the anticausative and reflexive voices. This prefix did not receive much attention in the literature because it was considered either (i) less productive (Chaker, 1995) or (ii) an allomorph of /m-/ when combined with a stem containing a labial consonant (Bensoukas, 2014; Boukous, 2009; Chaker, 1995; Elmedlaoui, 2012; Idrissi, 2001; Kossmann, 2007; Lahrouchi, 2018; a.o.). In this paper, I will start by showing that this prefix is in fact an independent morpheme in Taqbaylit. I will then discuss the issue of its quantitative allomorphy, illustrated below.

The data in (1) illustrate the two phonetic realizations of the prefix /n-/ depending on its right-context: it is realized as a geminate in a *_CC* context (1.i) and as a simplex in a *_CV* context (1.ii).

(1)	Verb	Gloss	n-verb	Gloss
i. <i>_CC</i>	zβəð	‘pull’	nn ə-zβað	‘stretch oneself’
	zlu	‘disappear’	nn ə-zli	‘self-exile’
ii. <i>_CV</i>	ħiz	‘put aside’	n -ħaz	‘put oneself aside’
	zəjzəw	‘be blue’	n -zəjzaw	‘become blue’

However, when this prefix is combined with the causative /s-/, it is always realized as a simplex, even in the context where it is otherwise geminated, as shown in (2).

(2)	Verb	n-verb	s-n-verb	Gloss s-n-verb
<i>_CC</i>	zβəð	nn ə-zβað	s-n ə-zβað	‘make stretch oneself’
	zlu	nn ə-zli	s-n ə-zli	‘push to self-exile’

In this paper, I will offer an analysis that establishes the phonological representation of the prefix /n-/ and explains the factors that govern its allomorphy.

The paper is organized as follows: section 2 establishes the independence of the morpheme /n-/ in Taqbaylit by arguing against the labial dissimilation hypothesis. Section 3 provides an overview of the theoretical framework: Strict CV Phonology and some principles of Government Phonology (Lowenstamm, 1996, 1999; Scheer, 2004). Section 4 summarizes some previous analyses and shows their limits when it comes to accounting for Taqbaylit data. Section 5 provides an analysis of the underlying

representation of the anticausative marker /n-/, its surface allomorphy and the nature of the verbal left-edge. Section 6 highlights in more detail the positions of the anticausative /n-/ and the reciprocal /m-/ in the template, precisely at the left-edge. Section 7 concludes the paper.

2. /n-/ as an independent morpheme in Taqbaylit

In this section, I argue against the labial dissimilation hypothesis in Taqbaylit and show that /n-/ is an independent morpheme. Indeed, this prefix has been previously considered as the result of the dissimilation of the morpheme /m-/ when combined with a stem containing a labial consonant (*cf.*, Bensoukas, 2004, 2014; Boukous, 2009; Chaker, 1995; Elmedlaoui, 2012; Idrissi, 2001; Koosmann, 2007; Lahrouchi, 2003, 2018; a.o.). This dissimilation applies only in the presence of the three labial consonants given in (3).

$$(3) \quad /m/ \rightarrow [n] / ___ C_{[+labial]} \dots \quad C_{[+labial]} = [f, \beta, m]$$

I will show that the hypothesis given in (3) does not apply in Taqbaylit although it is valid for some other Berber languages like Tashlhit (Bensoukas, 2014, Lahrouchi, 2018); Figuig Berber (Kossmann, 2007), Tamazight (Idrissi, 2001) and Tarifit (Mourigh & Kossmann, 2019). This point has already been mentioned by Elmedlaoui (2012) but without further details. I will provide the following evidence against this hypothesis: (i) the existence of m-verbs containing a labial consonant without dissimilating into [n-]; (ii) the existence of n-verbs that do not contain a labial consonant; (iii) the existence of minimal pairs of verbs with the prefixes /n-/ and /m-/, and (iv) the existence of verbs prefixed by /n-/ and /m-/ having different stems.

2.1 /m-/ is compatible with verbs containing labial consonants

While the dissimilation hypothesis states that the prefix /m-/ dissimilates into [n-] when it combines with a stem containing a labial consonant, the data in (4) show that this does not apply to Taqbaylit. This is because whatever the place of the labial consonant in the stem (C1 in (i), C2 in (ii), C3 in (iii)), there is no dissimilation of the reciprocal prefix /m-/ into [n-].

(4)	Verb	Gloss	m-verb	Gloss
i.	β udd	‘vow’	m-β udd	‘vow to each other’
	f akk	‘finish’	m-f akk	‘finish each other’
ii.	gaβ ər	‘look out for’	m-gaβ ər	‘look out for each other’
	sif	‘sieve’	m-sif	‘sieve each other’
	çum m	‘gag’	m-çum m	‘gag each other’

iii.	ħasəβ	‘judge’	m-ħasaβ	‘judge each other’
	ʃənnəf	‘pout’	m-ʃənnaf	‘pout at each other’
	ʃəkkəm	‘denounce’	m-ʃəkkam	‘denounce each other’

Moreover, when compared with the Tashlhit verbs which present a case of labial dissimilation (see (5) borrowed from Bensoukas (2014, p. 68)), we note that in these same verbs in Taqbaylit, the prefix /m-/ does not surface as [n-].

(5)	Verb	Tashlhit	Taqbaylit	Gloss m-verb
		/m-verb/	/m-verb/	
	/ħubbu/	nħubbu	m-ħubb	‘love each other’
	/sllm/	nsallam	m-salam	‘greet each other’
	/xlf/	nxalaf	m-xalaf	‘change each other’
	/fts/	nfattas	mjə-fθas	‘chop each other’

2.2 /n-/ is compatible with verbs without labial consonants

The data given in (6) show that /n-/ can combine with stems which do not contain any labial consonant. This is a second argument that refutes the labial dissimilation hypothesis of /m-/ into [n-].

(6)	Verb	Gloss	n-verb	Gloss
	qʃəɫ	‘throw away’	nnə-qʃaɫ	‘throw oneself away’
	ʃrəh	‘be happy’	nnə-ʃrəh	‘become happy’
	ʒlu	‘disappear’	nnə-ʒli	‘self-exile’
	rnu	‘add’	nnə-rni	‘grow’
	həwwəl	‘agitate’	n-həwwal	‘become excited’
	ðəqqəɾ	‘throw’	n-ðəqqar	‘throw oneself’
	six	‘collapse’	n-sax	‘(become) collapsed’
	ʒih	‘debauch’	n-ʒaħ	‘debauch oneself’

2.3 Minimal pairs of verbs with /n-/ and /m-/

The two arguments developed above show that there is no conditioning related to the nature of root segments and that the prefixes /n-/ and /m-/ are not in complementary distribution. Therefore, one expects to find minimal pairs of verbs that can combine both with the reciprocal /m-/ and the anticausative/reflexive /n-/. Some pairs of these verbs are given in (7).

(7)	Verb	m-verb	n-verb
	ʒβəð	mjə-ʒβað	nnə-ʒβað
	‘pull’	‘pull each other’	‘stretch oneself’

The example in (10.i) shows another property of m-verbs: their compatibility with a direct object. N-verbs, on the other hand, do not have this property, as they are always intransitive, as shown in (10.ii).

- (10) i. **mjə-ʒβað-ən** jərgazn=ənni ifassn=ənsən
 REC-pull.PFV-3M.P CS.men=DEM FS.hands=POSS.3M.P
 ‘The men pulled each other’s hands.’
- ii. **nnə-ʒβað-ən** jərgazn=ənni *ifassn=ənsən
 ANTC-pull.PFV-3M.P CS.men=DEM FS.hands=POSS.3M.P
 ‘The men stretched (individually).’ *their hands

All these facts show that n-verbs are different from m-verbs. This means that /m-/ and /n-/ are not allomorphs but distinct morphemes.

2.4 Same root but different stems

The data in (11) show pairs of n-verbs and m-verbs that are derived from the same roots but have different stems. This constitutes a fourth argument supporting the statement that /n-/ and /m-/ are different morphemes.

- | | | | |
|------|------|------------------------|---------------------|
| (11) | Verb | m-verb | n-verb |
| | ħiz | m-ħiz | n-ħaz |
| | | ‘put aside each other’ | ‘put oneself aside’ |
| | ðuɾɾ | m-ðuɾɾ | n-ɬəɾɾ |
| | | ‘harm each other’ | ‘suffer’ |
| | hudd | m-hudd | n-hədd |
| | | ‘destroy each other’ | ‘destroy oneself’ |
| | huzz | m-huzz | n-həzz |
| | | ‘shake each other up’ | ‘shake oneself’ |
| | afəj | mj-ufəj | n-fufəj |
| | | ‘fly to each other’ | ‘propagate’ |

The four arguments developed in this section show that the labial dissimilation hypothesis does not apply to Taqbaylit. This means that the prefixes /m-/ and /n-/ are not allomorphs but independent morphemes. In what follows, I will provide a detailed analysis of the phonological representation and the allomorphy of /n-/, but first I will sketch the theoretical framework that I adopt for my analysis. (For a detailed description of the syntactic and semantic properties of n-verbs, see Bedar (2022) and Bedar, Bendjaballah & Haiden (to appear)).

3. Theoretical framework

My analysis is couched in the CVCV framework, also called ‘Strict CV Phonology’, first proposed by Lowenstamm (1996) and further developed by Scheer (2004). After an outline of this theoretical framework, I will give an overview of two modules developed within this framework: the CV Initial hypothesis (Lowenstamm, 1999) and the vocalic length in Taqbaylit (Bendjaballah, 2004).

3.1 *Strict CV Phonology*

Strict CV Phonology was initially developed by Lowenstamm (1996) by extending the Standard Government Phonology (Kaye, Lowenstamm & Vergnaud, 1985, 1990). In this framework, the syllabic structure of constituents is represented at two levels: (i) the skeletal position level, which consists of a strict sequence of CV units; and (ii) the segment level. The segments are linked to skeletal positions by association lines: consonants to C-positions and vowels to V-positions.

The representations of some syllabic structures traditionally called ‘closed syllable’, ‘geminated consonant’, ‘long vowel’, and ‘final coda’ appear below in (12).

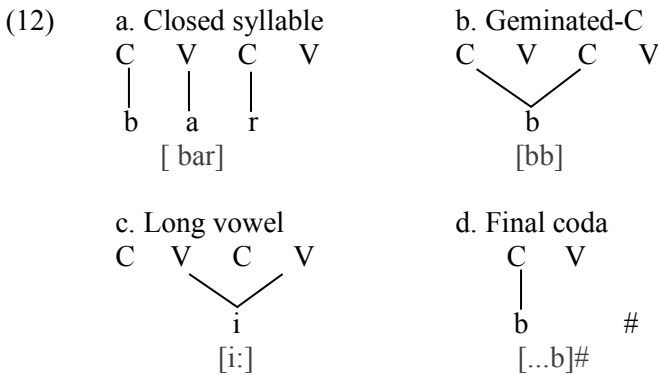

Proper government (PG) and Empty Category Principle (ECP) regulate the phonetic realization of a V-position (Kaye, Lowenstamm & Vergnaud, 1985, 1990).

(13) Proper government (PG):

- i) Given two vocalic positions V1 and V2, V2 governs V1 if and only if:
 - V1 and V2 are two adjacent positions,
 - V2 is located to the right of V1,
 - V2 is phonetically interpreted while V1 is an empty position.
- ii) A position V which is properly governed cannot in turn govern.

(14) Empty Categories Principle (ECP):

An empty V position that is properly governed must remain phonetically non-interpreted and a V position that escapes PG must be phonetically interpreted.

3.2 Initial CV Hypothesis

The hypothesis about the existence of an abstract morpheme without segmental content at the left-edge of Berber verb was first proposed by Guerssel (1992). Lowenstamm (1996) suggested that this morpheme is universal and located at the left-edge of major categories (noun, adjective and verb). The phonological, morphological, and prosodic operations that take place at the left-edge of the word target this empty morpheme. This latter is represented at the left-edge of the word by an empty CV unit substituting /#/ used in standard notations of Generative Phonology to mark the boundaries of the word, as illustrated in (15).

- | | | | | | | | | | | | | | | | | | | | |
|------------------------------|--------------------------------------------------------------------------------------------------------------------------------------------------------------------------------------------------------------------------------------------------------------------------------------------------------------------------------------------------------------------------------------------------------------------------------------------------------------------------------------------------------------------------------------------------------------------------------------------------------------------------------------------------------------------------------------------------------------------------------------------------------------------------|---|---|---|---|---|---|--|--|--|--|--|--|---|---|---|---|--|--|
| (15) a. Generative Phonology | b. Strict CV Phonology | | | | | | | | | | | | | | | | | | |
| #xǽm# | <table border="1" style="border-collapse: collapse; text-align: center; width: 100%;"> <tr> <td style="padding: 2px 5px;">C</td> <td style="padding: 2px 5px;">V</td> <td style="padding: 2px 5px;">C</td> <td style="padding: 2px 5px;">V</td> <td style="padding: 2px 5px;">C</td> <td style="padding: 2px 5px;">V</td> </tr> <tr> <td style="border: none;"> </td> <td style="border: none;"> </td> <td style="border: none;"> </td> <td style="border: none;"> </td> <td style="border: none;"> </td> <td style="border: none;"> </td> </tr> <tr> <td style="border: none;">x</td> <td style="border: none;">ǽ</td> <td style="border: none;">ə</td> <td style="border: none;">m</td> <td style="border: none;"></td> <td style="border: none;"></td> </tr> </table> | C | V | C | V | C | V | | | | | | | x | ǽ | ə | m | | |
| C | V | C | V | C | V | | | | | | | | | | | | | | |
| | | | | | | | | | | | | | | | | | | | |
| x | ǽ | ə | m | | | | | | | | | | | | | | | | |

3.3 Vocalic length in Taqbaylit

According to Bendjaballah (2004), Taqbaylit vowels are phonologically long although they are phonetically realized as short. This means that phonological length is interpreted as phonetic quality, and not quantity (Lowenstamm, 1991; Hammond, 1997). In this sense, vocalic elements need two V-positions to surface as vowels (16.a-c). If they have access to only one V-position, this position remains empty or realized as schwa (16.d).

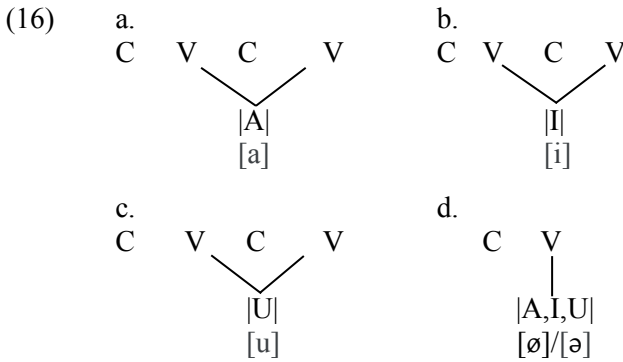

Bendjaballah (2004, p. 54)

4. Previous analyses

The allomorphy of derivational prefixes has received several analyses within different theoretical frameworks (Bendjaballah, 2007; Dell & Elmedlaoui, 2002; Guerssel, 1992; Jebbour, 1999; Lahrouchi, 2018, and references therein). I will focus here on two previous analyses couched within the autosegmental phonology framework: Guerssel (1992) based on Ait Seghrouchen Tamazight and Lahrouchi (2018) based on Tashlhit. I first show that these two analyses cannot account for the Taqbaylit data (including n-verbs) and then provide an alternative analysis that can account for the allomorphy of /n-/ and other derivational morphemes.

In (17), I contrast the two analyses. In Guerssel’s analysis in (17.a), the causative prefix /s-/ is floating, and the representation involves an ‘*abstract morpheme*’ (bold in (17.a)) that is consistently at the left-edge of a simple or derived form. On the other hand, in Lahrouchi’s analysis in (17.b), the causative prefix /s-/ is associated with its own skeletal material, and the abstract morpheme, which is a CV unit, is always present at the left-edge of the stem (bold in 17.b).

(17) a. Guerssel (1992)

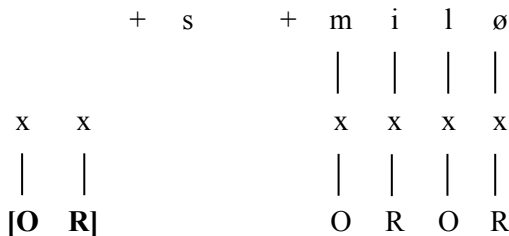

b. Lahrouchi (2018)

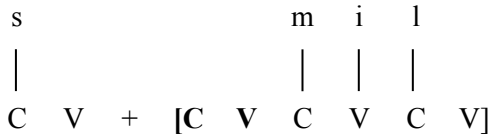

I summarize the analysis of Guerssel (1992) in subsection 4.1, then the one of Lahrouchi (2018) in subsection 4.2. I conclude by confronting the two analyses with Taqbaylit data in subsection 4.3.

4.1 Guerssel’s analysis (1992)

Guerssel’s analysis thus involves an abstract morpheme at the left periphery of the derived form. To derive the causative form, two operations are necessary. First, the syllabification of the causative prefix (18.a), then its propagation on the abstract morpheme (18.b). The generated form contains a geminate prefix [ss-].

(18) a. Syllabification

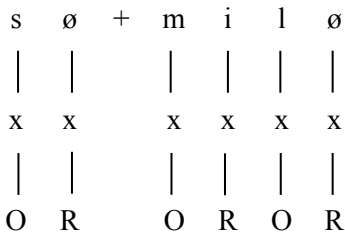

b. Propagation on the abstract morpheme

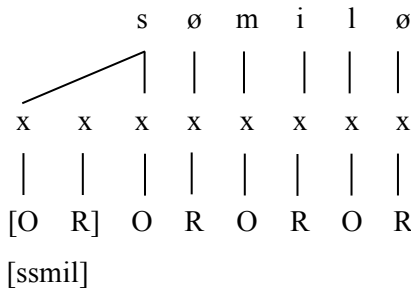

The same mechanism is involved in the derivation of forms with two prefixes, as illustrated by the data in (19) in which the first prefix is always geminated.

(21) Combination of derivational prefixes (Lahrouchi 2018:13-14)

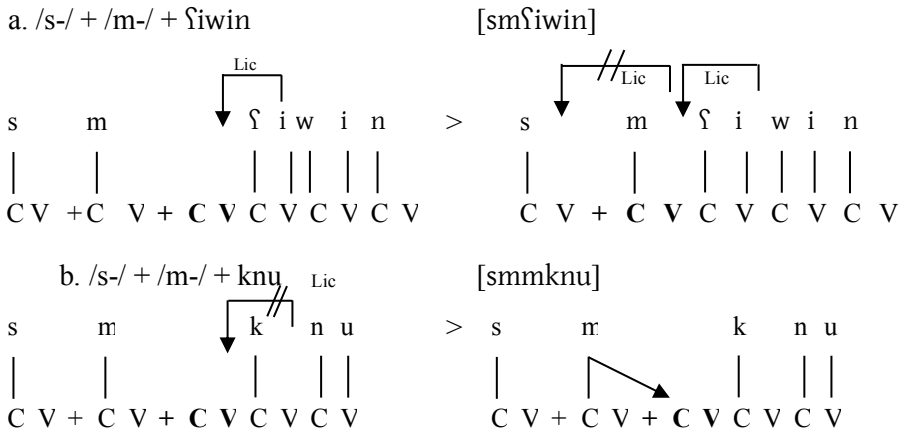

It will be shown below that this analysis does not account for Taqbaylit data either.

4.3 Evaluating the analyses in light of Taqbaylit data

There are both formal and empirical arguments against the two analyses mentioned above. The arguments that I would like to bring are empirical in nature, but have implications for the theoretical aspects of the phonological representation of derivational morphemes and their allomorphy. These arguments are based on the comparison of the facts in the two languages on which the previous analyses were carried out with those of Taqbaylit, the subject of this study.

The data in (22) summarize the facts observed in the three languages:

- Regarding prefix combination, Taqbaylit is different from Tashlhit and Tamazight since the reciprocal systematically precedes the causative, as shown in (22.i).
- Regarding the surface realizations in $_CV$ context (22.ii), one expects to have a geminate /s-/ in Tashlhit following proper government. This is however not the case.
- Regarding the surface realizations in $_CC$ context (22.iii), the data from Tashlhit and Tamazight show that at least one of the prefixes has a geminate form. In Taqbaylit, however, the combination of any two prefixes blocks gemination, as also illustrated by the data in (23).

(22)	Language	Tamazight (Guerssel)	Tashlhit (Lahrouchi)	Taqbaylit
i.	Combinations	/s-m/	/s-m/	/m-s/ *s-m
ii.	_CV	ssə-m	sm	ms-
iii.	_CC	ss-mm	s-mm	ms-

(23) Combination of prefixes in Taqbaylit

a.	s + n	Verb	Gloss	n-verb	s-n-verb
		qsəf	‘break’	nnə -qsaf	s-nə -qsaf
		rnu	‘add’	nnə -rni	s-nə -rni
b.	m + s	Verb	Gloss	m-verb	m-s-verb
		rnu	‘add’	mjə -rnu	m-sə -rnu
		xðəm	‘work’	mjə -xðəm	m-sə -xðəm
		ali	‘climb’	mj-ali	m-s-ali

In this section, I showed that Guerssel and Lahrouchi’s analyses cannot account for the Taqbaylit data. In the next section, I will provide a novel analysis that can explain the pattern observed in this language.

5. Analysis

5.1 Proposal

To account for the surface allomorphy of the prefix /n-/ in Taqbaylit, I propose that:

- 1) The left-edge of the verb has two CV sites, as illustrated with the verb *mil* in (24.a);
- 2) /n-/ is a simplex and floating morpheme (24.b). Its CV position is closer to the stem, namely CV-I2;

(24) a. Two CV sites at the verbal left-edge

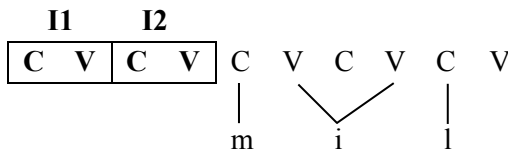

b. /n-/: simplex floating morpheme

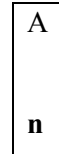

- 3) If CV-I1 is licensed, it can be exploited by the propagation of /n-/.

5.2 Allomorphy of the prefix /n-/

The question that now arises is: if there are two CV sites at the left-edge of the stem, and if /n-/ is always on the same site (CV-I2), what governs its allomorphy in both forms in (25)? In other words, why is /n-/ geminated in (25.a) but remains simplex in (25.b) while the number of CV sites is the same?

(25) a. /n-/ + qsəf

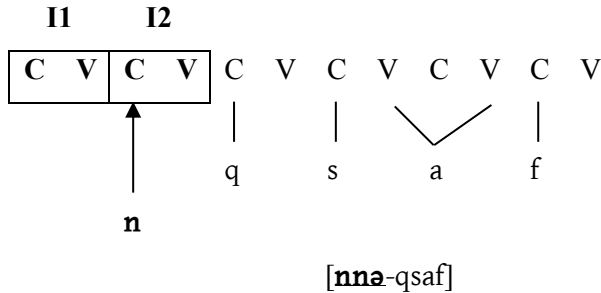

b. /n-/ + sax

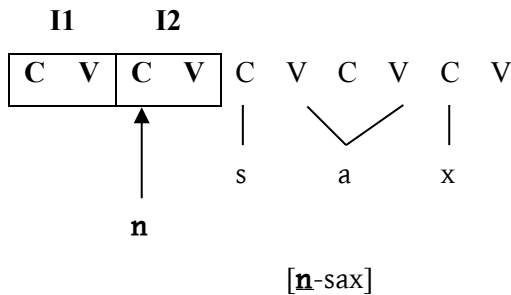

This question finds a simple answer in the principle of Licensing within the Strict CV framework. Indeed, if CV-I1 is licensed, it is identified by the propagation of /n-/. If it is not licensed, it is not identified.

To see how the analysis works, let us start with the form with a geminate /n-/ in (26). The prefix /n-/ is on CV-I2. The V position of CV-I2 is not properly governed and can therefore be realized. In doing so, it licenses CV-I1. The latter is exploited by the propagation of /n-/. Therefore, the geminated form is obtained.

(26) a. Association of /n/ to CV-I2

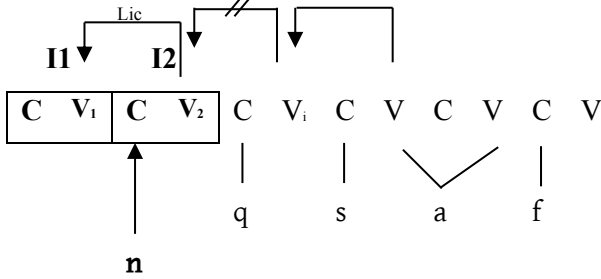

b. Propagation of /n/

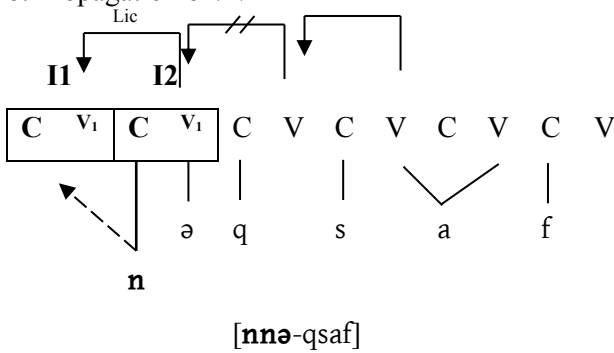

(27) illustrates the second case where /n-/ remains simplex. The V position of CV-I2 is properly governed by the stem vowel. Therefore, it cannot be expressed, and it cannot license CV-I1 either. /n-/ is unable to identify C1 and cannot geminate.

(27) a. Association of /n/ to its position

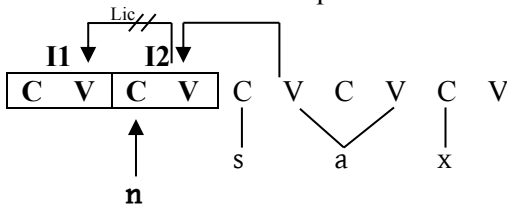

b. Non-propagation of /n-/

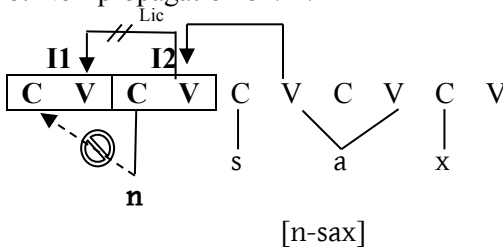

If the allomorphy of /n-/ is governed by the Licensing principle, then why would we need to introduce a templatic property that relies on the presence of two CV sites at the left-edge of the verb? The answer to this question will be discussed in the next subsection.

5.3 Why two CV sites at the left-edge of the verb?

The goal here is to show that the allomorphy of /n-/ is not only governed by the licensing principle, but also by a templatic constraint according to which there are only two CV sites for derivational morphemes at the left-edge of the verb. There are three arguments in favor of this hypothesis: (i) /n-/ and /s-/ both surface as simplex when combined; (ii) there is no place for the glide [j] when the reciprocal /m-/ is combined with the causative /s-/.; and (iii) there is a distributional gap when one expects to have a simplex morpheme combined with a geminate.

5.3.1 Combination of /n-/ and /s-/

The first argument in favor of the two CV hypothesis comes from the combination of /n-/ with the causative /s-/. In this case, given in (28) and illustrated in (29), these two prefixes always surfaced as simplex when combined. In other words, there are only two available positions that the prefixes share.

(28) Combination of /n-/ with /s-/

Verb	n-verb	s-n-verb	
qsəf 'break'	nnə -qsaf	s-nə -qsaf	* sə-nnə -qsaf * ssə-n -qsaf
rnu 'add'	nnə -rni	s-nə -rni	* sə-nnə -rni * ssə-n -rni
zluləf 'be flamed'	nnə -zluləf	s-nə -zluləf	* sə-nnə -zluləf * ssə-n -zluləf

(29) a. /n-/ + qsəf

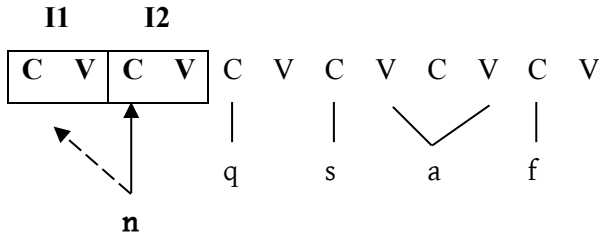

[**nna**-qsaf]

b. /s/ + /n-/ + qsəf

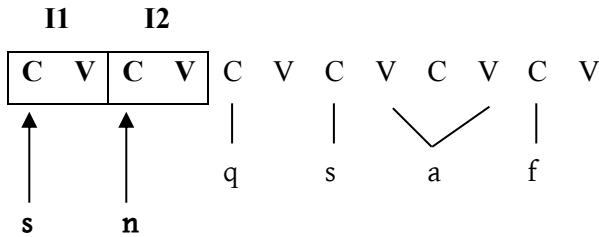

[**s-na**-qsaf]

My hypothesis predicts that we will not find combinations of two morphemes with one being geminated. This is because there are only two CV sites available at the left-edge of the verb³. The ungrammatical forms given in (28), whose representations are given in (30), confirm this prediction.

(30) a. s-n-verb

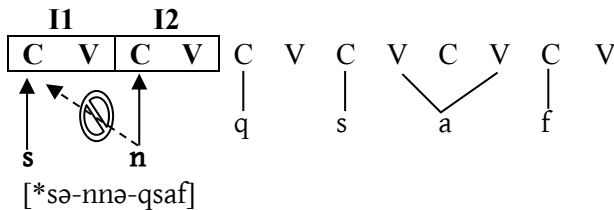

³ See Bendjaballah & Haiden (2008) for a similar proposal on nouns. However, in Bendjaballah's (2007, 2014), the verb is represented with a single initial CV.

b. s-n-verb

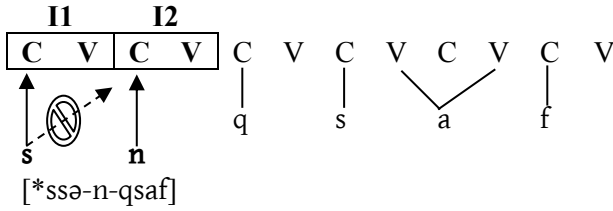

5.3.2 No place for [j] when /m-/ is combined with /s-/

Another argument in favor of the two CV sites hypothesis comes from the combination of the reciprocal /m-/ and the causative morpheme /s-/. When /m-/ occurs in a $_CC$ or a $_VC$ context, it requires glide [j] insertion, as illustrated in (31.a), where the glide occupies the C position of CV-I2. However, when this prefix combines with the causative morpheme /s-/, glide insertion is blocked. This follows from the hypothesis advocated here. Since there are only two CV sites available at the left periphery of the verb and the C position of CV-I2 is already occupied, there is no free position that could host the glide. This is illustrated in (31.b).

(31) a. m-verb

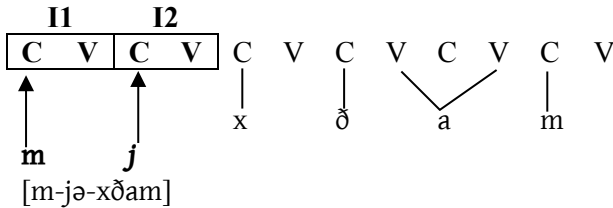

b. m-s-verb

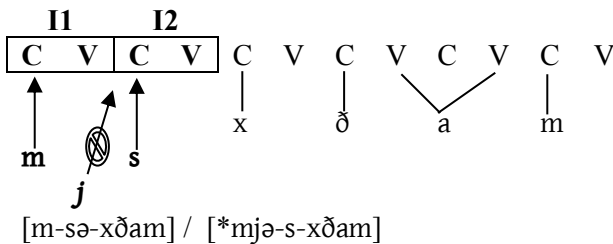

5.3.3 Distributional gap

The distributional gap cases illustrated in (32) provide a third argument in favor of my hypothesis. When two prefixes combine with a verb beginning with a CV sequence, the Proper government rules predict gemination of the

(35.a). On the other hand, in a $_CV$ context (35.b), both morphemes are simplex. Finally, in a $_VC$ context (35.c), the prefix /n-/ triggers the reduplication of the first radical consonant, whereas /m-/ surfaces followed by a glide [j].

(34)		/ $_C_1C$	/ $_C_1V$	/ $_VC_1$
	i.	/n/ → [nnə]	[n]	[nC ₁]
	ii.	/m/ → [mjə]	[m]	[mj]
(35)	a.	CCəC VERB		DERIVED VERB
	i.	/n-/ qsəf 'break'		nnə -qsaf 'be broken'
	ii.	/m-/ ʒβəð 'pull'		* mmə -ʒβəð / mjə -ʒβəð 'pull each other'
	b.	CVC(V) VERB		DERIVED VERB
	i.	/n-/ ħiz 'put aside'		n -ħaz 'put aside oneself'
	ii.	/m-/ wali 'see'		m -wali 'see each other'
	c.	VCəC VERB		DERIVED VERB
	i.	/n-/ afəj 'fly'		*nn-afəj / n -fufəj 'propagate'
	ii.	/m-/ ačər 'steal'		mj -ačər / * m -çučər 'steal each other'

To account for these different behaviors of the two morphemes, I propose that each prefix has its own position in the verbal template: /m-/ is hosted on CV-I1 and /n-/ is hosted on CV-I2, as illustrated in (36) with the verb ʒβəð 'pull'.

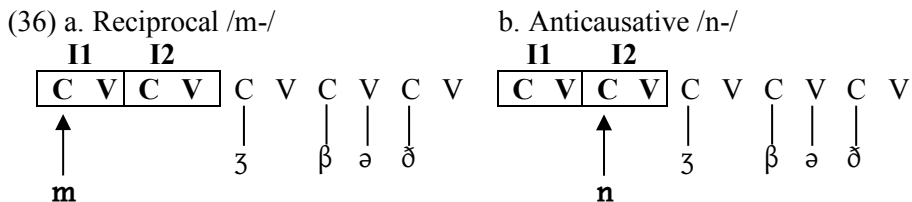

In the following subsections I will discuss the arguments in favor of this hypothesis. I begin with the position of the anticausative /n-/ and then turn to the position of the reciprocal /m-/.

6.2 The position of /n-/

I proposed in the previous section that /n-/ is hosted on CV-I2. I provide now the arguments that support this hypothesis.

The first argument is the degemination of /n-/ when it combines with the causative /s-/. Indeed, /n-/ can geminate if CV-I1 to its left is licensed (37.a). However, when this CV is occupied by the prefix /s-/, it cannot geminate (37.b). This means that its initial site cannot be CV-I1, but CV-I2.

(37) a. /n-/ + ʒβəð

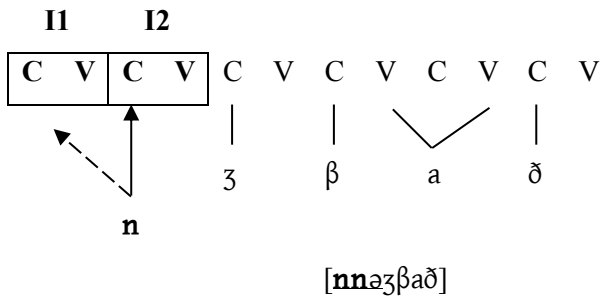

b. /s/ + /n-/ + ʒβəð

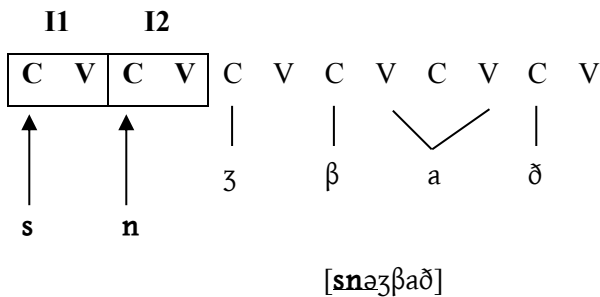

The second argument concerns the order of the two prefixes. Indeed, if there are two CV sites at the left-edge, the inversion of the two morphemes should be possible because they are both phonologically simplex. However, this is not the case. The data in (38) show that /s-/ systematically precedes /n-/. This means that the position of /n-/ is always CV-I2.

(38)	Verb	Gloss	n-verb	s-n-verb	*n-s-verb
	zβað	‘pull’	nnə -zβað	s-nə -zβað	*n-sə -zβað
	rnu	‘add’	nnə -rni	s-nə -rni	*n-sə -rni
	zluləf	‘be flamed’	nnə -zluləf	s-nə -zluləf	*n-sə -zluləf
	izwiγ	‘be red’	nnə -zway	s-nə -zway	*n-sə -zway
	huzz	‘shake up’	n -həzz	sə-n -həzz	*nə-s -həzz
	ðəqqəf	‘push’	n -dəqqəf	sə-n -dəqqəf	*nə-s -dəqqəf
	afəj	‘fly’	n -fufəj	sə-n -fufəj	*nə-s -fufəj

Based on these observations, I conclude that the position of /n-/ is CV-I2, as illustrated below with the verb *zβað* ‘pull’.

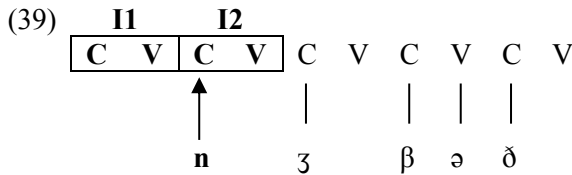

6.3 The position of /m-/

In this subsection, I will show that the position of the reciprocal /m-/ is CV-I1. The first argument in favor of this hypothesis is the suppression of the epenthetic glide [j] when this prefix is combined with the causative /s-/, as shown in the examples given in (40).

(40)	Cont.	Verb	m-verb	m-s-verb
	/_CC	xðəm ‘do, work’	mjə -xðəm	m-sə -xðəm *mjə-ssə-xðəm *mə-ssə-xðəm * mjə-s-xðəm
	/_VC	ali ‘climb’	mj -ali	m-s -ali *mjə-ss-ali *mə-ss-ali *mjə-s-ali

The glide [j] in (41.a) is an epenthetic segment that occupies an empty CV position inside the domain. Its absence in the presence of the causative /s-/ reveals its epenthetic status (41.b). This means that /m-/ is not closest to the stem and is hosted on CV-I1.

(41) a. m-verb

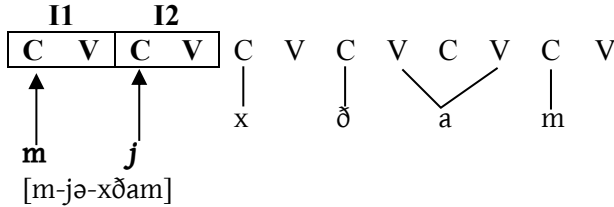

b. m-s-verb

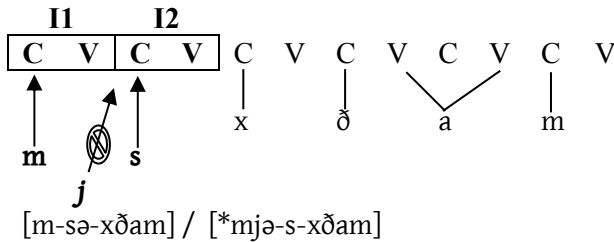

The second argument for a specific position (CV-I1) for /m-/ is the order in which it combines with the causative prefix /s-/. If the two morphemes are phonologically simplex, they could in principle combine in any order. However, /m-/ cannot follow /s-/, as illustrated by the examples in (42). This means that /m-/ is not close to the stem.

(42)	Cont.	Verb	m-s-verb	*s-m-verb	Gloss-Verb
	_CC	xðəm	m-sə-xðam	*s-mə-xðam	‘do, work’
		rnu	m-sə-rnu	*s-m-rnu	‘add’
		ɣluləq	m-sə-ɣluləq	*s-mə-ɣluluq	‘be hanged’
	_VC	ali	m-s-ali	*s-m-ali	‘climb’
		açi	m-s-açi	*s-m-açi	‘wake up’
		argu	m-s-argu	*s-m-argu	‘dream’

Based on the two previous arguments, I conclude that the reciprocal prefix /m-/ has its own specific position, which is CV-I1, as illustrated in (43) with the verb *ʒβəð* ‘pull’.

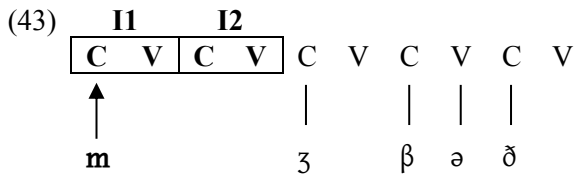

7. Conclusion

In this paper, I analyzed the allomorphy of the anticausative prefix /n-/ and showed that it is phonologically simplex, like two other derivational prefixes: the causative /s-/ and the reciprocal /m-/. The phonetic realization of this floating morpheme /n-/, in simplex or geminate version, is governed by both Licensing and the structure of the verbal left-edge, which contains two CV sites.

I also argued that the variation in allomorphy between the prefixes /n-/ and /m-/ results from the position of CV sites hosting these prefixes: /n-/ is hosted on the CV site closest to the stem, CV-I2, whereas /m-/ is hosted on the other site, CV-I1. This implies that the prefixation of segments to skeletal positions is not done in an arbitrary way. In a phonology-syntax interface approach where skeletal positions are syntactically identified, labeling the two initial CVs of the verbal left-edge in the syntax is a challenge for future research.

References

- Bedar, A. (2022). *Morphophonologie et structure argumentale des verbes anticausatifs en kabyle* (Doctoral dissertation). Nantes Université, Nantes.
- Bedar, A., Bendjaballah, S. & Haiden, M. (to appear). The verbal n-stem in Taqbaylit Berber. In Meyer, Ronny & Chris Reintges (Eds.). *Perspectives on Templatic Morphology*, ZDMG.
- Bendjaballah, S. (2014). Remarks on nonconcatenative affixation. *Brill's Journal of Afroasiatic Languages and Linguistics*, 6(1), 45-73.
- Bendjaballah, S. (2007). Constraints and markers in templates. *Proceedings of the 32 Incontro di Grammatica Generativa*, 21-34.
- Bendjaballah, S. (2004). Longueur phonologique des voyelles en kabyle. *Etudes et documents berbères*, 22(1), 47-69.
- Bendjaballah, S. & Haiden, M. (2008). A Typology of Emptiness in Templates. In J. Hartmann, V. Hegedüs & H. van Riemsdijk (Eds.), *Sounds of Silence: Empty Elements in Syntax and Phonology* (pp. 23-59). Oxford: Elsevier.
- Bensoukas, K. (2004). Markedness, faithfulness, and consonant place in Tashlhit roots and affixes. *Langues et Littératures*, 18, 115-153.
- Bensoukas, K. (2014). *Featural dissimilation in Tashlhit: Avoiding the repetition of [labial] and [round]*. Rabat: Publications of Faculté des Lettres et Sciences Humaines.

- Boukous, A. (2009). *Phonologie de l'amazighe*. Rabat: Publications of Institut royal de la culture amazighe.
- Chaker, S. (1995). Diathèse (voix). *Encyclopédie berbère*, (15), 2297-2303.
- Dell, F., & Elmedlaoui, M. (2002). *Syllables in Tashlhiyt Berber and in Moroccan Arabic*. Dordrecht: Springer Science & Business Media.
- Elmedlaoui, M. (2012). Berber. In L. Edzard (ed.), *Semitic and Afroasiatic: Challenges and opportunities* (pp. 131-198). Wiesbaden: Harrassowitz Verlag.
- Guerssel, M. (1992). The phonology of Berber derivational morphology by affixation. *Linguistic Analysis*, 22(1-2), 3-60.
- Hammond, M. (1997). Vowel quantity and syllabification in English. *Language*, 73, 1-17.
- Idrissi, A. (2001). *Towards a root-and-template approach to shape-invariant morphology* (Doctoral dissertation) Université du Québec à Montréal.
- Jebbour, A. (1999). Syllable weight and syllable nuclei in Tachelhit Berber of Tiznit. *Cahiers de Grammaire*, 24, 95-116.
- Kaye, J., Lowenstamm, J., & Vergnaud, J. R. (1990). Constituent structure and government in phonology. *Phonology*, 7(1), 193-231.
- Kaye, J., Lowenstamm, J., & Vergnaud, J. R. (1985). The internal structure of phonological elements: a theory of charm and government. *Phonology*, 2(1), 305-328.
- Kossmann, M. (2007). Berber morphology. In A.S. Kaye, (ed.), *Morphologies of Asia and Africa*, Vol. 1 (pp. 429-46). Winona Lake, Indiana: Eisenbrauns.
- Lahrouchi, M. (2018). The left edge of the word in the Berber derivational morphology. *Glossa: a journal of general linguistics*, 3(1).
- Lahrouchi, M. (2003). Manifestations gabaritiques dans la morphologie verbale du berbère (parler chleuh d'Agadir). *Recherches linguistiques de Vincennes*, (32), 61-82.
- Lahrouchi, M. (2001). *Aspects morpho-phonologiques de la dérivation verbale en berbère tachelhit* (Doctoral dissertation). Université Paris 7.
- Lowenstamm, J. (1999). The beginning of the word. *Phonologica*, 153-166.
- Lowenstamm, J. (1996). CV as the only syllable type. *Current trends in phonology: Models and methods*, 2, 419-441.
- Lowenstamm, J. (1991). Vocalic length and syllable structure in Semitic. In A.S. Kaye, (ed.), *Semitic studies in honor of Wolf Leslau on the occasion of his 85th birthday* (pp. 949-965). Wiesbaden: Harrassowitz.
- Mourigh, K. & Kossmann, M. (2019). *An Introduction to Tarifit Berber (Nador, Morocco)*. Ugarit-Verlag: Lehrbücher orientalischer Sprachen IV/1.
- Scheer, T. (2004). *A lateral theory of phonology: What is CVCV, and why should it be?* (Vol. 1). Berlin: Walter de Gruyter.